

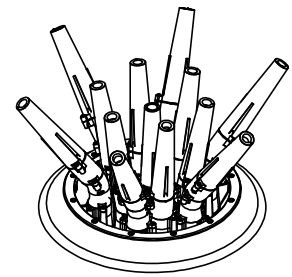

Fusion Series: DOUBLE ARCH

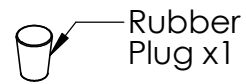

Parts Needed:

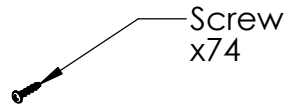
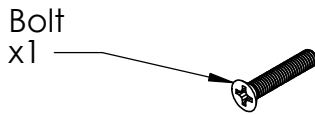
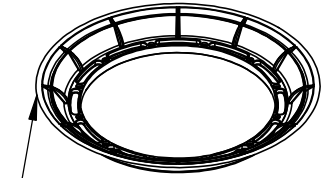
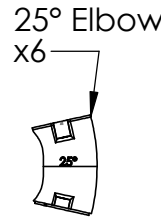
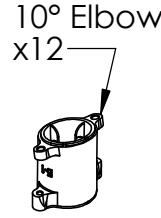
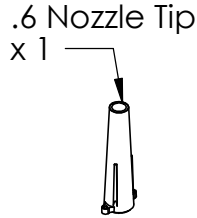
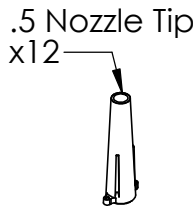
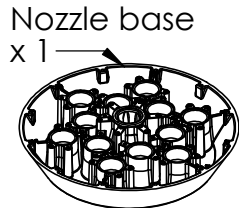

1. Assemble Nozzle Groups:

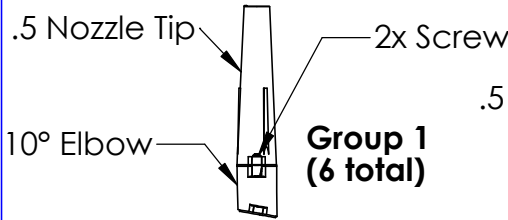

**Group 1
(6 total)**

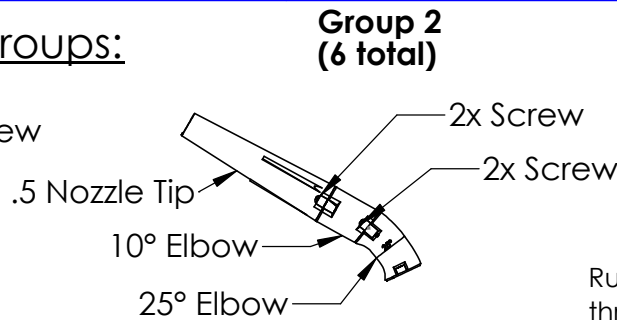

**Group 2
(6 total)**

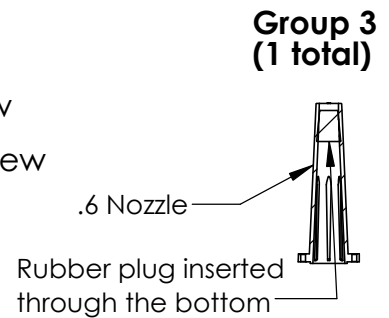

**Group 3
(1 total)**

2. Install Nozzle Groups to Base

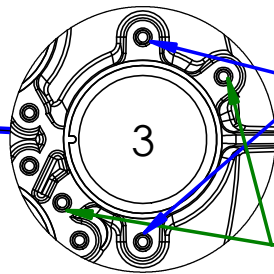
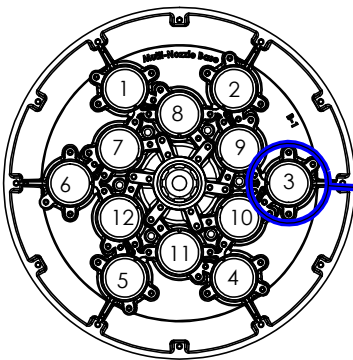

Install 6x **Group 1** Nozzles on holes 7-12

Install 6x **Group 2** Nozzles on holes 1-6

Use these holes normally so that nozzles point straight away from the center

For a Twister setup install **Group 1** using the rotated (45°) holes shown here

3. Attach the Nozzle Base

For a Stationary Pattern:

Secure the Nozzle Base to the Unit using the bolt that goes through the center hole

Next secure the Center Nozzle (**Group 3**) to the center hole

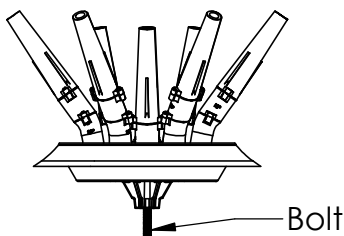

For a Twister:

Follow the instructions detailed on the "Installing Twister Module" page